

1 Drawer-at-a-time Mechanism R Line

Assembly Guide



Mécanisme 1-à-la-fois Ligne R

Guide d'assemblage

- All required hardware is included.
- Please check the contents with your packing slip.
- Read instructions carefully.
- Save this document for future reference.

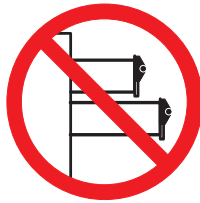

- *Toute la quincaillerie requise est incluse.*
- *Veillez vérifier le contenu avec votre feuille de livraison.*
- *Lisez attentivement les instructions.*
- *Conservez ces instructions pour référence future.*

Hardware

Tapping screw
Vis taraudeuse
3D1618L2



Glide
Glissière
71019300

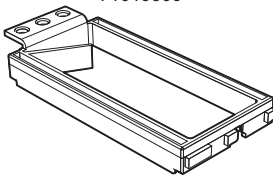

Runner
Coulisseau
71019600

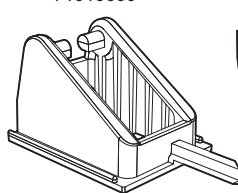

Quincaillerie

Locking block
Bloc d'activation
71019000

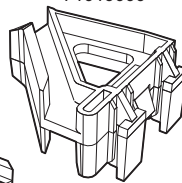

Tools Required Outils requis



Note :

It is possible that you may receive more plastic pieces than you need depending on the number of drawers you have.
Il peut y avoir des pièces en plastique en trop selon le nombre de tiroirs dans votre cabinet.

Locking Block Assembly

Assemblage du bloc d'activation

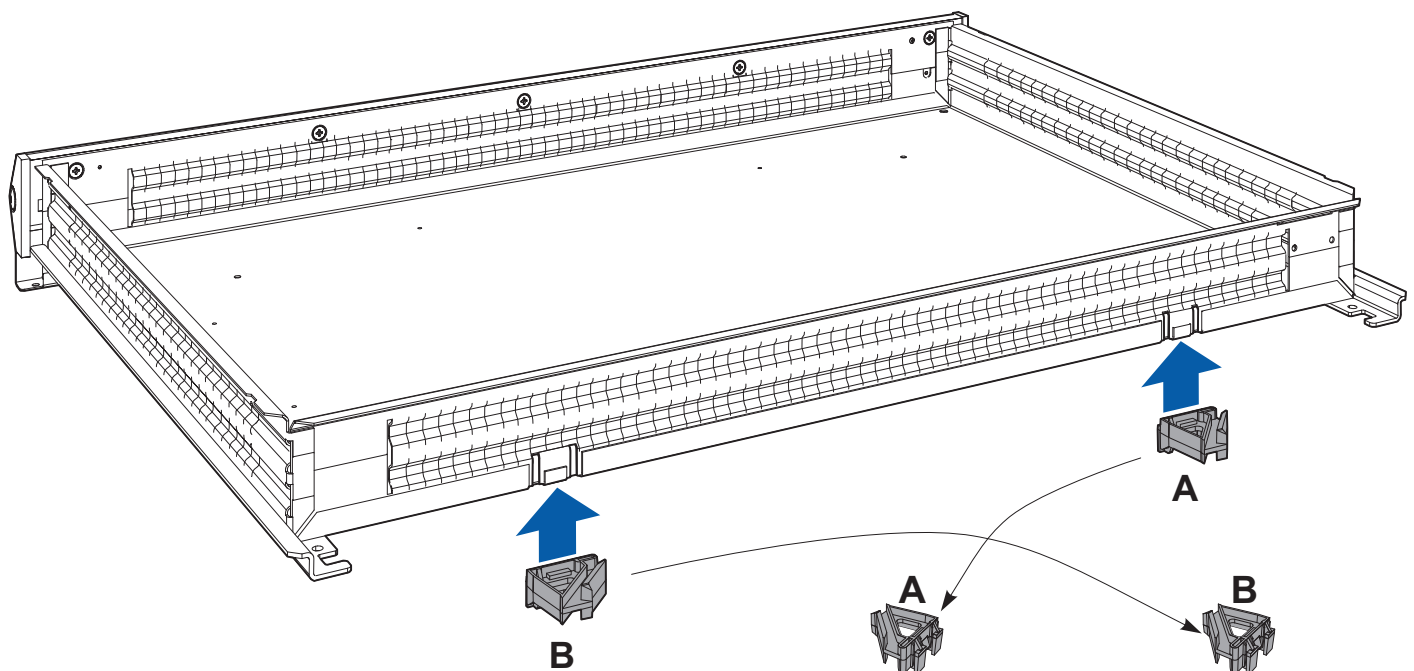

- For regular cabinets, install all locking blocks in position "B".
- For multi-drawer cabinets, install all locking blocks in position "A" and "B" as illustrated.
- *Pour les cabinet régulier, installer tous les blocs d'activation dans la position "B".*
- *Pour les cabinets multi-tiroirs, installer tous les blocs d'activation dans la position "A" et "B", tel qu'illustré.*

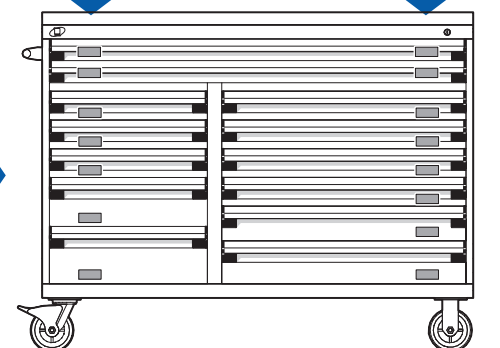

Bar Assembly

Assemblage de la barre

2x  5/8"

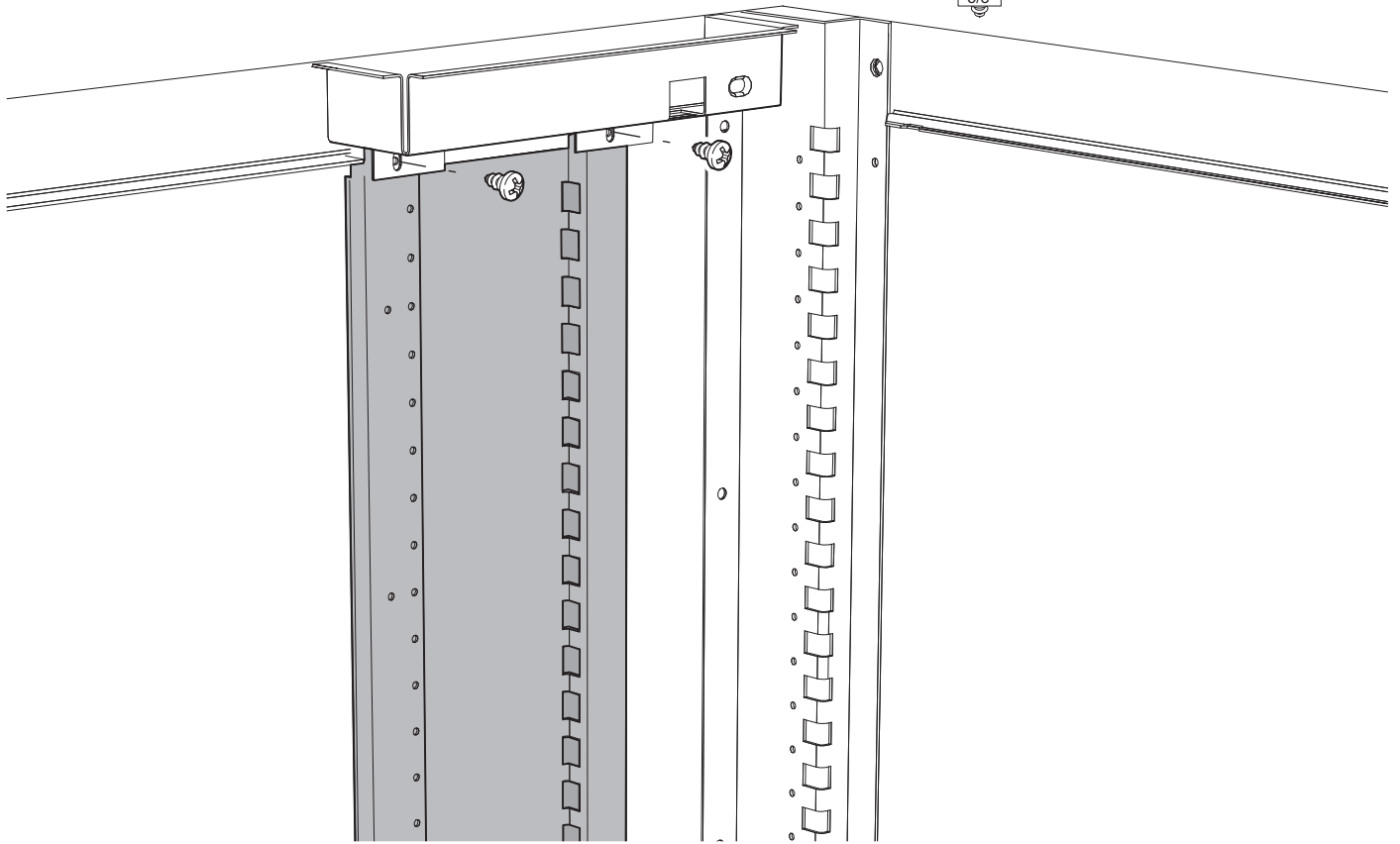

Glide and Runner

Glissière et coulisseau

 5/8"

2 per drawer / par tiroir

